

Rayco RG27, RG35, & RG37 *Quadwheel*[®] Installation & Operation Guide



If you have any questions or concerns, *please call 1-800-473-3683*



BEFORE YOU BEGIN

Read these instructions completely and carefully.

- **Note to installer** – Be sure to leave these instructions for the consumer’s use.
- **Note to consumer** – Keep these instructions with your Owner’s Manual for future reference.
- **Skill level** – Installation of the wheel requires intermediate mechanical skills. Proper installation is the responsibility of the installer. Product failure due to improper installation is not covered under any warranty.
- **Helpful tips** – When installing a new v-belt it is recommended to check belt tension after 1 hour, 5 hours, 10 hours and 25 hours of machine operation as the belt will stretch.

IMPORTANT - Before you continue, please check the packing list to make sure it matches the contents of the boxes.



Disconnect Power

to machine to prevent any machine components from moving before proceeding. Failure to do so could result in death or serious injury.

FOR YOUR SAFETY read and observe all **CAUTIONS** and **WARNINGS** shown throughout these instructions. While performing the installations that are described in this booklet, gloves & safety glasses or goggles should be worn at all times.

Installation Preparation

TOOLS SUPPLIED:

½" Drive, ½" 6pt Impact Allen Wrench Socket

TOOLS YOU WILL NEED:

5/8" Socket Wrench
½" Drive Torque Wrench
Green-Seize™

TORQUE SETTINGS:

900 Series® Nut: 35ft. lbs. (47Nm)
LoPro® Bolt (lubricated with Green-Seize™): 180ft. lbs.
LoPro® Bolt (dry): 240ft. lbs.

MANUFACTURER'S PARTS LIST:

<i>Part Number</i>	<i>Description</i>
926-WS2	900 Series® Wearsharp® 2-sided Tooth, for wheels 22" & smaller, Used with Greenwheel® & Quadwheel®
GW-BLOCK	Mounting Block for Greenwheel® & Quadwheel®
GW-HOLDER	Tooth Holder Greenwheel® & Quadwheel®
LP-300	3" LoPro® Bolt
ALLENWRENCH-SOCKET	½" Drive, ½" 6pt Impact Allen Wrench Socket
BR-RG27	Bearing Riser
RAYCO-BELT*	Band 2/A66 Belt For Rayco Upgrade
RAYCO-SHEAVE*	Sheave for Rayco Upgrade

**If your machine already has a 9" sheave, then you will not need to replace your belt & sheave.*

Green Manufacturing, Inc.
9650 Packard Rd
Morenci, MI 49256
Phone 800.473.3683 • Fax 517.458.1550



Table of Contents

Disassembly Instructions	4
Quadwheel ® Assembly Instructions	10
Assembling the Quadwheel ® to Machine	11
Quadwheel ® Drive Assembly – Expanded View	16
Taper-Lock® Bushing Removal & Installation Instructions	17
Split Taper Bushing Removal & Installation Instructions	18
Quadwheel ® Procedure for Cutting a Stump	19
Quadwheel ® Guarantee	21
Material Safety Data Sheet	22

Disassembly Instructions

1. Remove clutch assembly guard bolts and remove the cover. (Figure 1.1)
2. Remove the upper belt guard bolts and remove the cover. (Figure 1.2)

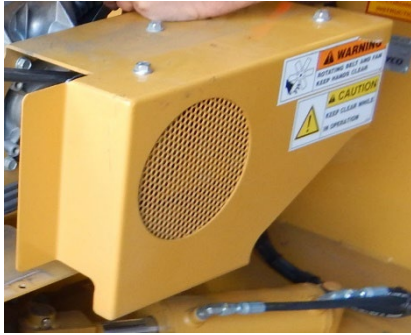

Figure 1.1



Figure 1.2

3. Remove the lower belt guard bolts and remove the cover. (Figure 1.3)
4. Loosen four (4) motor mount bolts. Back the motor mount adjustment bolt off approximately 1". (Figure 1.4)
5. Slide the engine towards the cutter wheel to loosen the upper drive belt.



Figure 1.3

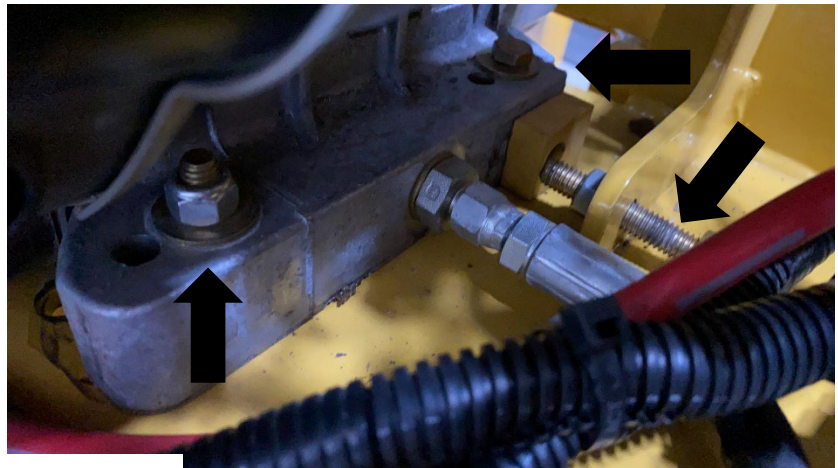

Figure 1.4



If your machine already has a 9" sheave, it is not necessary for you to install the new belt & sheave. In this case, please skip steps 6 through 12.

6. Loosen & remove the 5/8" shaft bolt in the center of the clutch. It may take several taps to initially loosen the bolt. Remove the clutch assembly and set off to the side. (Figure 1.5)



Figure 1.5

7. Remove the upper drive belt. Set it off to the side. It will be replaced with the new belt included in your **Quadwheel®** setup.
8. Measure from the back of the upper drive cover to the backside of the jackshaft v-belt sheave. Record this measurement here, as you will need it for reassembly. (Figure 1.6)

Sheave Measurement Notes:



Figure 1.6

9. Remove the jackshaft v-belt sheave and bushing. Set sheave off to the side. It will be replaced with the new sheave included in your **Quadwheel®** setup. **Follow split taper bushing removal instructions found on page 18.** (Figure 1.7)
10. Install the new sheave and bushing to the previously recorded measurement in step 8. (FIG 1.8) Periodically recheck sheave measurement while tightening bushing mounting bolts to ensure alignment. **Please refer to split taper bushing installation instructions on page 18.**



Figure 1.7



Figure 1.8

11. Install the new belt included with your **Quadwheel®** setup. Note: When new belts are being installed it is advised to check belt tension after 1 Hour, 5 Hours, 10 Hours, and 25 Hours of machine operation as the belt will stretch.

Belt Tension Check: 1 Hour 5 Hours 10 Hours 25 Hours

12. Reinstall clutch assembly. Belt tension will be set later in the instructions.

13. Remove the jackshaft cover. (Figure 1.9)

14. Loosen jackshaft bearing bolts. **Do not remove bolts.** (Figure 1.10)

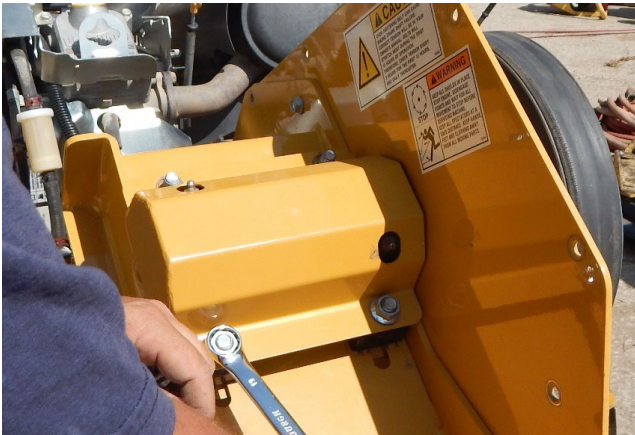

Figure 1.9

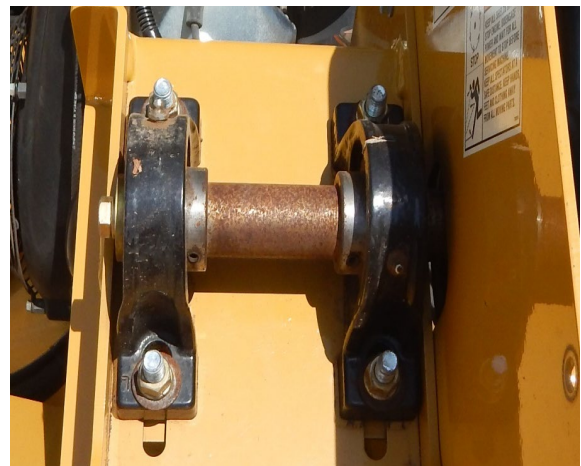

Figure 1.10

15. Loosen the bearing tensioner for the jackshaft assembly. (Figure 1.11)

16. Pull top sheaves forward to loosen the bottom drive belt and remove the bottom drive belt from the bottom sheave. (Figure 1.12)



Figure 1.11



Figure 1.12

17. Measure from the back of the bottom belt cover to the front of the cutter wheel shaft sheave. Record this measurement here, as you will need it for reassembly. (Figure 1.13)

Sheave Measurement Notes:



Figure 1.13

18. Loosen and remove lower sheave retaining bolt. (Figure 1.14)



Figure 1.14

19. Remove cutter wheel sheave. **Follow Taper-Lock® bushing removal instructions on page 17.**
20. Loosen and remove bottom belt cover backplate bolts. (Figure 1.15)



Figure 1.15

21. Remove the bottom belt cover backplate.
22. Loosen and remove left pillow block bearing bolts. (Figure 1.16)

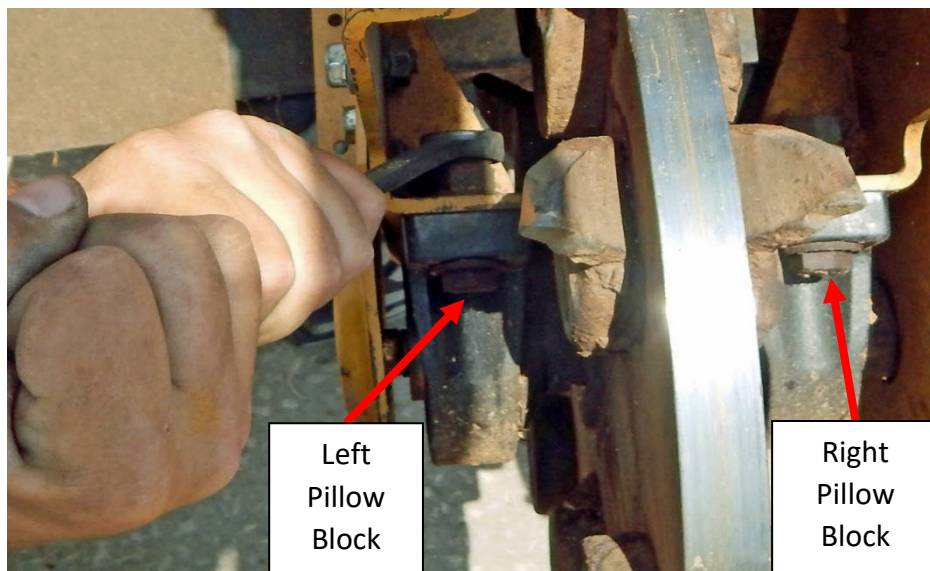



Figure 1.16

 **Warning: The cutter wheel assembly weighs approximately 112 lbs. Use caution when loosening bolts. Cutter wheel assembly may drop unexpectedly.** Floor jack or equivalent lowering device is recommended for easier removal. (Figure 1.16)

23. Remove right pillow block bearing bolts. (Figure 1.16)
24. Remove and lower cutter wheel assembly.
25. Loosen two (2) set screws on both the left and right side bearing collars. (Figure 1.17)

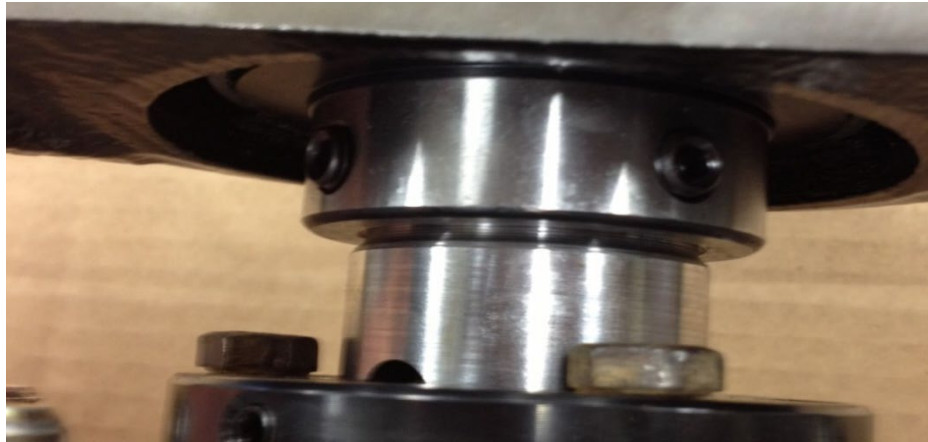

Figure 1.17

26. Remove bearings from the cutter wheel shaft. In some instances, bearings may need to be pressed off or cut away from the shaft.
27. Remove the left and right cutter wheel spacers from the cutter wheel shaft.
28. Remove cutter wheel from the cutter wheel shaft. **Follow split taper bushing removal instructions on page 18.** (Figure 1.18)



Figure 1.18

Quadwheel® Assembly Instructions

(Use Figure 2.1 for the next 10 steps)

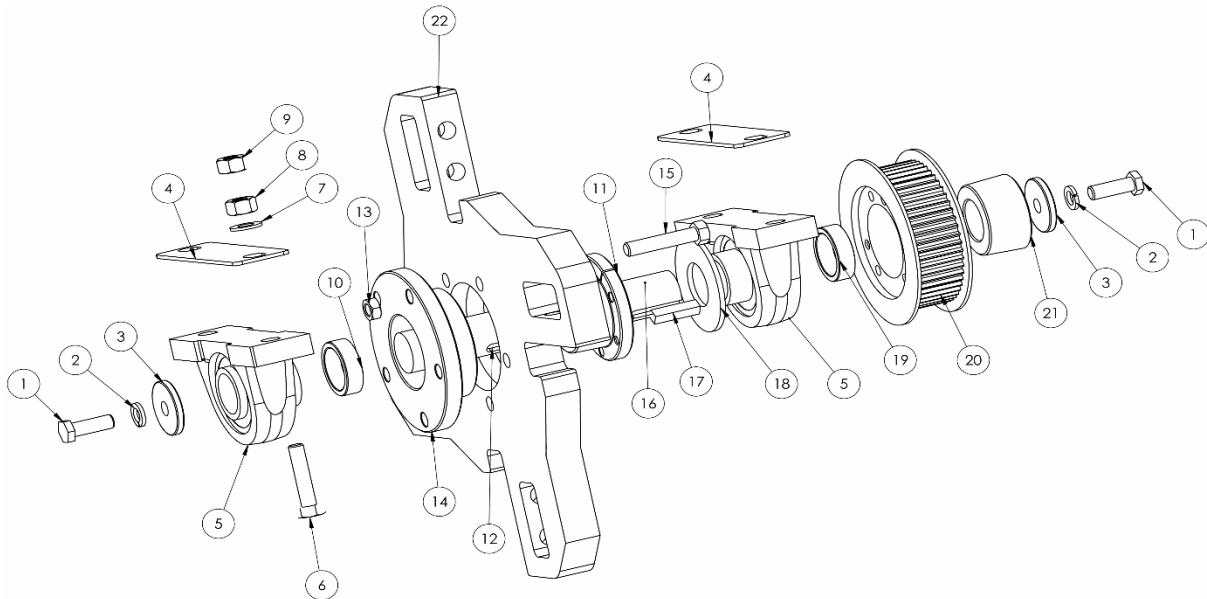

Figure 2.1

1. Mount hub (14) using bolts (15) to **Quadwheel®** (22).
2. Thread nuts (13) to bolts (15) and torque down firmly.
3. Slide bushing (11) into the hub (14). Thread bushing (11) bolts into the hub (14) loosely. Bushing (11) should have some play on the cutter wheel shaft (16).
4. Assemble keyway (12) into the cutter wheel shaft (16).
5. Slide cutter wheel shaft (16) into bushing (11) aligning keyway (12) with bushing (11).
6. Slide the left cutter wheel spacer (10) on the cutter wheel shaft (16).
7. With the bearing (5) collar facing the **Quadwheel®** (22), slide the left bearing (5) onto the hub (14) side of the cutter wheel shaft (16). Tighten two Allen head set screws in the bearing (5) collar.
8. Assemble bolt (1), lock washer (2), and heavy washer (3) into the hub side of the shaft.
9. Slide the right cutter wheel spacers (18) on the cutter wheel shaft (16).
10. With the bearing (5) collar facing the **Quadwheel®** (22), slide the right bearing (5) onto the bushing (11) side of the cutter wheel shaft (16). Tighten two Allen head set screws in the bearing (5) collar.

Assembling the *Quadwheel*[®] to Machine

1. With the bolt holes from the bearings lined up with those on the machine, set cutter wheel in place onto the machine. **A floor jack or equivalent lifting device is recommended for easier installation.**
2. Install a bearing riser (4) between the right bearing (5) and the frame of the machine, lining up the bolt holes of the bearing (5) and bearing riser (4). (Figure 2.1, page 10)
3. Reinstall the bearing mounting bolts (6) on with the flat washer (7) and nuts (8 & 9) loosely to the right side of the *Quadwheel*[®] (22 & 23), making sure the bearing riser (4) is in position. (Figure 2.1, page 10)
4. File away 1/8" of material around cutter wheel shaft hole in the bottom belt back side cover. A hand file should be sufficient. (Figure 3.1)



Figure 3.1

5. Slide bottom belt back side cover over shaft in the appropriate direction. Reinstall bottom belt back side cover and bolts. (Figure 3.2)



Figure 3.2

6. Install a bearing riser (4) between the left bearing (5) and the frame of the machine, lining up the bolt holes of the bearing (5) and bearing riser (4). (Figure 2.1, page 13)
7. Reinstall the bearing mounting bolts (6) on with the flat washer (7) and nuts (8 & 9) loosely to the right side of the **Quadwheel**[®] (22), making sure the bearing riser (4) is in position. (Figure 2.1, page 10)
8. Tighten all 4 bearing mounting bolts.
9. With the **Quadwheel**[®] slightly off-center to the left, thread cutter wheel bushing bolts $\frac{1}{4}$ of a turn evenly around the bushing. After each rotation of the wheel, check the center position of the **Quadwheel**[®] to ensure proper centering (Figure 3.3). Adjust **Quadwheel**[®] assembly as needed to maintain proper centering. Tighten bushing bolts completely as outlined in the **split taper bushing removal instructions on page 18**.

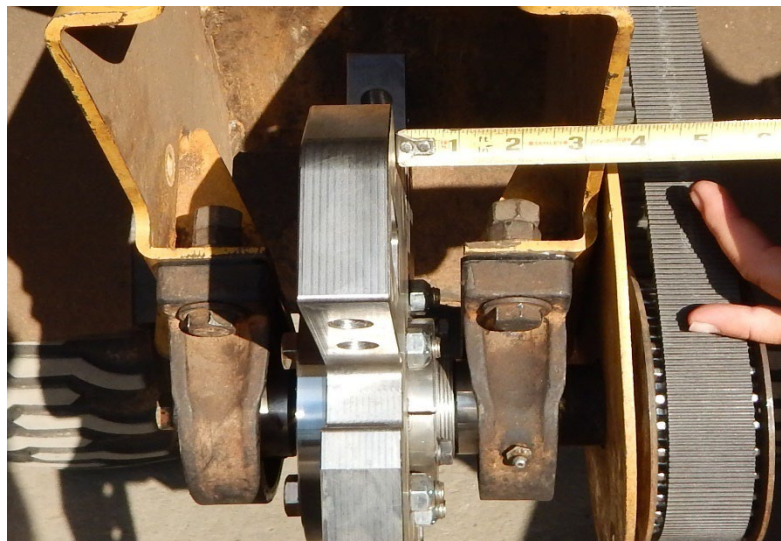

Figure 3.3

10. Loosely install **Quadwheel**[®] holders and mounting blocks to the wheel. Insert **LoPro**[®] bolts, lubricated with **Green-Seize**[™] or equivalent lubricating compound. Torque the wheel holder bolts evenly until you've reached 180 ft. lbs. (240ft. lbs. dry) on each bolt. (Figure 3.4)
11. Install **Greenteeth**[®] on all holder positions and torque to 35 ft. lbs. (Figure 3.4)

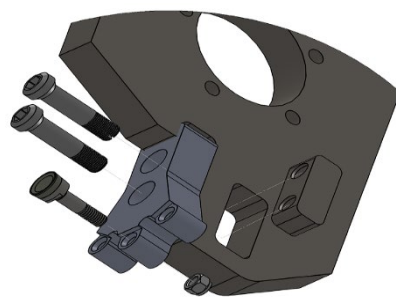

Figure 3.4

12. Manually rotate the wheel to ensure each tooth position will have suitable clearance inside the cutter wheel guard. (Figure 3.5)



Figure 3.5

13. Reinstall bottom drive belt sheave and bushing to the measurement recorded on page 10. **Follow Taper-Lock® bushing installation instructions on page 17.** (Figure 3.6)



Figure 3.6

14. Manually rotate **Quadwheel®** several times and visually ensure the bottom drive belt maintains center position to both bottom drive belt sheaves. If the bottom drive belt does not maintain center position on bottom drive belt sheaves, then adjustments will need to be made. Loosen the bottom belt drive bushing and repeat step 13 until the bottom drive belt maintains a center position on bottom drive belt sheaves.

15. Reinstall bottom drive belt sheave bolt and heavy washer to the cutter wheel shaft. (Figure 3.7)



Figure 3.7

16. Reinstall bottom drive belt into bottom belt assembly. (Figure 3.8)



Figure 3.8

17. Realign jackshaft bearings. Ensure there is proper tension to the bottom belt. Tighten jackshaft bearing tensioners until a suitable tension to the bottom belt is achieved. Tighten Jackshaft bearing nuts. (Figure 3.9)

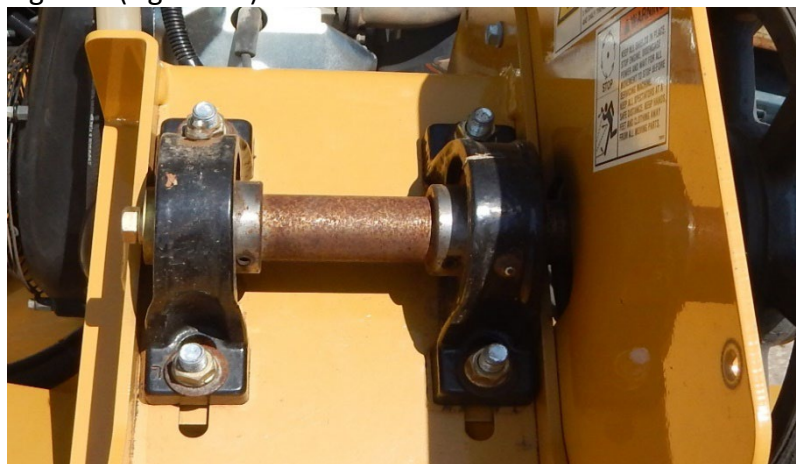

Figure 3.9

18. Reinstall top drive belt. (Figure 3.10)



Figure 3.10

19. Tighten engine mount tensioner checking periodically to ensure proper tension to top drive belt.

20. Once proper tension to the top drive belt is achieved, tighten motor mount nuts and bolts. (Figure 3.11)

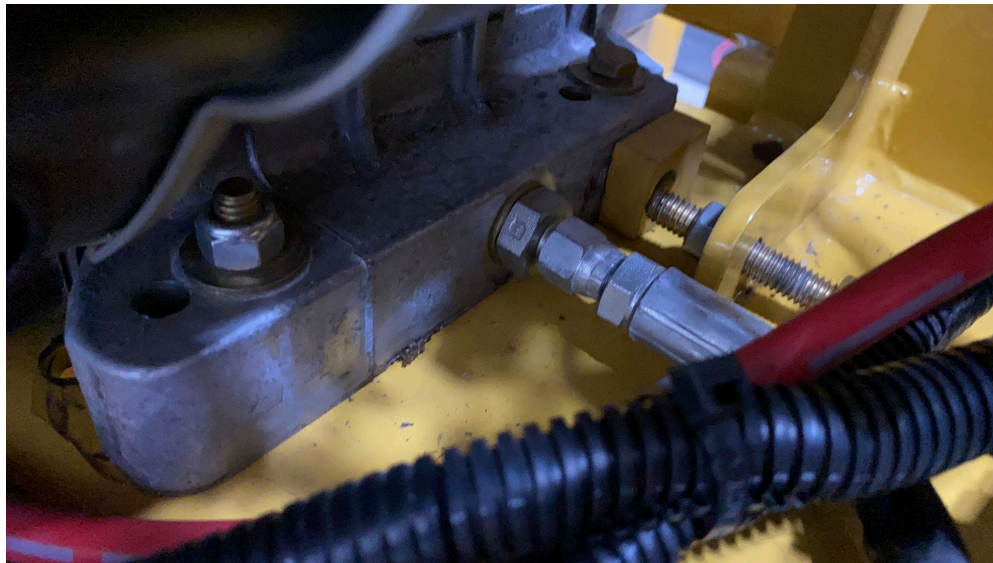

Figure 3.11

21. Reinstall the bottom drive belt cover.

22. Reinstall the top drive belt cover.

23. Reinstall the clutch assembly guard cover.

24. Reconnect power to the machine.

25. Start the machine engine and engage the **Quadwheel**[®].

26. Ensure no unusual noises are emanating from the machine.

Quadwheel® Drive Assembly – Expanded View

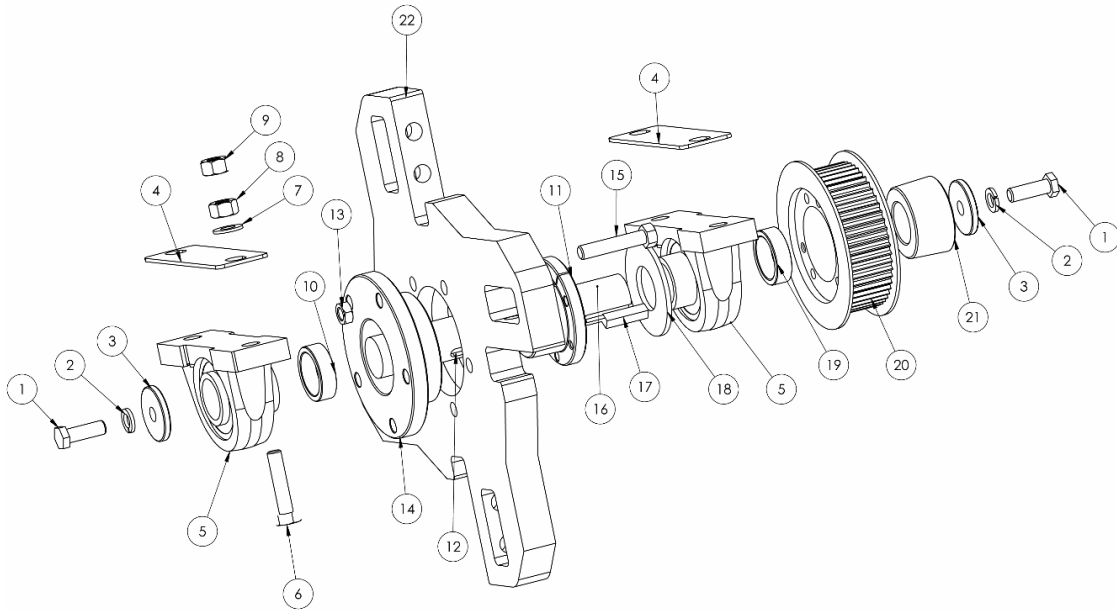

Quadwheel® Drive Assembly			
Item #	Part #	Description	Qty
1		Hex Bolt 1/2 - 13 X 1	2
2		1/2 Lock Washer	2
3		1/2 Heavy Washer	2
4		Bearing Riser	2
5		Bearing - PB (1-1/2)	2
6		Hex Bolt 9/16 - 12 X 2-1/4	4
7		5/8" Washer	4
8		Hex Nut 9/16 – 12 GR8	4
9		Hex Nut 9/16 – 12 GR8	4
10		Left Cutter Wheel Spacer 1-1/2" x 0.690"	1
11		Bushing - QD SK X 1-1/2	1
12		3/8 Keystock X 1 5/8"	1
13		Hex Lock Nut 1/2 - 13	5
14		Cutter Wheel Hub	1
15		Hex Bolt 1/2 – 13 X 2-1/2	5
16		Cutter Wheel Shaft	1
17		3/8 Keystock X 1 1/4"	1
18		Right Cutter Wheel Shaft Washer 1-1/2" X 14 GA	2
19		Cutter Wheel Shaft Spacer 1.50" X 1.321"	1
20		(32T) Sheave	1
21		Bushing 2517 X 1-1/2	1
22		Quadwheel®	1

Taper-Lock® Bushing Removal & Installation Instructions

⚠ Warning: Use of Anti-Seize lubricant on tapered cone surfaces or on bolt threads when mounting may result in damage to sheaves. This voids all manufacturers' warranties.

1. To remove from the shaft:
 - a. Remove all screws. (If equipped loosen the keyway **set screw** located on large diameter)
 - b. Insert screws in holes indicated by ● on drawing (Figure 4.1). Loosen bushing by alternately tightening screws by following torque specs (Table 1.1).
2. Installation Instructions:
 - a. Clean shaft, the bore of the bushing, outside of bushing, and hub bore of all oil, paint, and dirt. File away burrs.
 - b. Insert bushing into the hub. Match the hole pattern, not threaded holes. Each complete hole will be threaded on one side only.
 - c. Lightly oil set screws and thread into those half-threaded holes indicated by ○ on the drawing (figure 4.1).

CAUTION: Do not lubricate the bushing taper, bushing bore, hub taper, or the shaft. Doing so could result in breakage of the product.
 - d. Position assembly onto the shaft allowing for the small axial movement which will occur during the tightening procedure.
 - e. Alternately torque setscrews to the recommended torque setting in chart below.

CAUTION: Do not use worn hex key wrenches. Doing so may result in a loose assembly or may damage screws.
 - f. To increase the gripping force, lightly hammer the face of the bushing using a drift or sleeve. Do not hit the bushing directly with a hammer.
 - g. Re-torque screws after hammering.

CAUTION: Where bushing is used with lubricated products such as chain, gear or grid couplings be sure to seal all pathways (where lubrication could leak) with RTV or similar material.
 - h. Recheck screw torques after initial run-in, and periodically thereafter. Repeat steps e, f, and g, if loose.

Insert Screw Torque Table	
Bushing Type	Wrench Torque in./lbs.
2517	430

Table 1.1

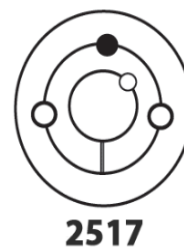

○ Insert Screws to Install ● Insert Screws to Remove

Figure 4.1

Split Taper Bushing Removal & Installation Instructions

 **Warning:** Use of Anti-Seize lubricant on tapered cone surfaces or on bolt threads when mounting may result in damage to sheaves. This voids all manufacturer’s warranties.

1. To Remove from Shaft:
 - a. Remove the set screw if applicable. Remove cap screws and insert them into tapped holes in the bushing flange. (Figure 5.1)
 - b. Tighten progressively until the bushing disengages.
 - c. Remove assembly from shaft.
2. Installation Instructions:
 - a. Wipe the bushing barrel, bushing bore, and shaft clean with a soft dry cloth. Remove paint & other foreign material from the bore of the mating part. **Do not lubricate the bushing, bore of the mating part, shaft, or cap screws.**
 - b. Put bushing loosely into the hub. Start cap screws by hand, turning them just enough to engage threads. Do not use a wrench at this time.
 - c. Slide assembly onto shaft. Line up drive components.
 - d. Tighten cap screws progressively with a torque wrench until each has been tightened to correct torque. (Table 2.1) Install set screw if applicable.

Bolt Torque Table		
Bushing Type	Cap Screw Size	Wrench Torque in./lbs.
P	5/16 - 18	192
Q	3/8 - 16	348
SK	5/16 - 18	180
SF	3/8 - 16	360

Table 2.1



Figure 5.1
(Bushing Only Pictured)

Quadwheel® Procedure for Cutting a Stump



Always follow all warnings and safety guidelines referenced in your equipment manufacturer's manual.

1. Prepare the Machine:
 - a. Drive the machine into position with the cutting wheel shaft above the top front edge of the stump. (Figure 6.1)



Figure 6.1

- b. Engage **Quadwheel®** and move the engine throttle to Fast. (Figure 6.2)



Figure 6.2

- c. While moving the boom left and right, adjust the Left/Right travel to as slow as possible. (Figure 6.3)

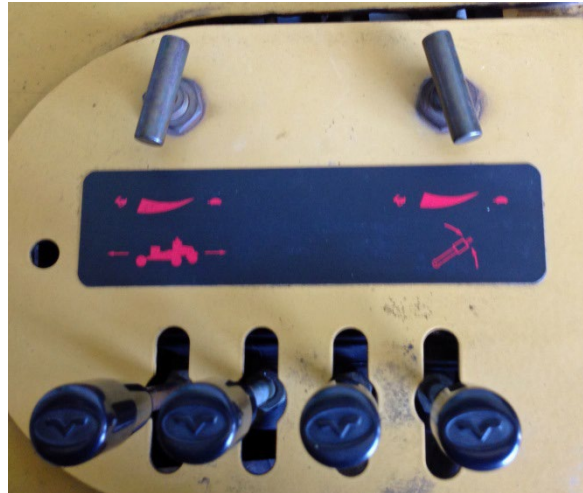

Figure 6.3

2. Fine Tune Travel Speed

- a. Lower the **Quadwheel**[®] into the stump. With travel speed set to its lowest setting, swing the cutting wheel across the stump removing as much material as your machine will comfortably cut. Slightly increase the travel speed until the **Quadwheel**[®] is comfortably removing as much material as possible in a single pass. Repeat if necessary (Figure 6.4)



A depth of cut greater than 1 ½ inches greatly increases the possibility of holder wear and voids all product warranties.



Figure 6.4

QUADWHEEL® GUARANTEE

NEW SETUPS AND FIRST-TIME CUSTOMERS:

If you purchase a **Quadwheel®** setup and are not completely satisfied with its performance, please contact Green Manufacturing at 800.473.3683 to request a return authorization within 90 days of the purchase date for a product refund or exchange.

WARRANTY:

If you are not completely satisfied with your purchase, please contact Green Manufacturing, Inc. at 800.473.3683 to request a return authorization within 30 days of the purchase date for a product refund or exchange. We strive to provide exceptional quality products. Our products undergo a stringent quality control process, however, if you feel that there is an issue with the quality of your product, please contact Green Manufacturing, Inc. immediately. We will accept unused parts for return or exchange for up to 30 days from the date of purchase with proof of purchase included with the return.

Seller's warranties against defects and non-conformities and defects shall continue to apply only so long as the Goods: (i) have been installed, maintained, and used in conformity with instructions furnished by Seller from time to time, if any, and otherwise in conformity with the highest industry practices; (ii) have been subjected to normal use for the purpose for which the Goods were designed; (iii) have not been subjected to misuse, negligence or accident; (iv) have not been altered or repaired by persons other than Seller or Seller authorized warranty service providers in any respect which, in the judgment of Seller, adversely affects the condition or operation of the Goods; and (v) have been fully paid for. IN NO EVENT SHALL SELLER BE LIABLE FOR ANY SPECIAL, INDIRECT, EXEMPLARY, INCIDENTAL, CONSEQUENTIAL, OR PUNITIVE LOSSES OR DAMAGES (INCLUDING, WITHOUT LIMITATION, BUSINESS INTERRUPTION, REVENUE OR PROFITS, FEES OR FINES), EVEN IF SELLER HAS BEEN ADVISED OR MADE AWARE OF THE POSSIBILITY OF ANY SUCH LOSSES OR DAMAGES AND REGARDLESS OF WHETHER THE CLAIM IS BASED ON CONTRACT, TORT, STRICT LIABILITY, OR OTHER THEORY OF LIABILITY. Seller's cumulative liability for all losses and damages under these General Terms and Conditions or under any of the Related Agreements (including, without limitation, those arising out of contract tort (including negligence), strict liability, warranty, or other theory of liability) shall not exceed (a) in the case of any services provided or to be provided by Seller, the amount of the fees payable by Buyer for such services under the applicable Related Agreement, and (b) in the case of any products or devices provided or to be provided by Seller, the amount of Seller's labor services associated with the product sale. Seller reserves the right to make, without notice to Buyer, alterations to a product that do not materially affect agreed specifications or the product's form, fit, or function.

MATERIAL SAFETY DATA SHEET

I - PRODUCT IDENTIFICATION

Trade Name: Tungsten Carbide **Chemical Family:** Refractory Metal Alloy

Chemical Formula: WC **CAS#:** 12070-12-1

II - HAZARDOUS INGREDIENTS

Hazardous Components % OSHA/PEL ACGIH/TLV Sec. 302 Sec. 304 Sec. 313

Tungsten Carbide 0-100 N/E N/E No No No

Tungsten compounds 0-100 5 mg/m³ C - 1 0 mg/m³ No No No

HM IS Ratings (0-4): Health: 3 **Flammability:** 0 **Reactivity:** 0

HM IS Protective Equipment: H: glasses, gloves, clothing, combo respirator

III - PHYSICAL DATA

Boiling Point: 6000 oC **Melting Point:** 2820 - 2940 oC

Evaporation Rate: N/A **% Volatiles:** N/A

Solubility in H₂O: Insoluble **Vapor Pressure:** N/A

Vapor Density: N/E **Specific Gravity:** 13.6 gm/cc at 18 oC

Appearance and Odor: Grey to black powder, odorless **Molecular Weight:** 195.86

IV - FIRE AND EXPLOSION HAZARDS DATA

Flash Point: N/A **Flammability:** Non-Flammable

Explosive Limits: Lower: N/A **Upper:** N/A

Extinguishing Media: Use suitable extinguishing media for surrounding materials and type of fire.

Special Fire Fighting Procedures: Firefighters must wear full face, self-contained breathing apparatus with full protective clothing to prevent contact with skin and eyes. Fumes from fire are hazardous. Isolate runoff to prevent environmental pollution.

Unusual Hazard: Dusts may present a fire or explosion hazard under rare favoring conditions of particle size, dispersion, and strong ignition source. However, this is not expected to be a problem under normal handling conditions.

V - HEALTH HAZARD INFORMATION

Routes of Entry: Inhalation, ingestion, skin or eye contact (for dusts, mists, powder, and fume).

Effects of Overexposure: Industrially tungsten does not constitute an important health hazard. Exposure is related chiefly to the dust arising out of the crushing and milling operations. Chronic inhalation of the dust may cause lung damage in humans. Heavy exposure to the dust or the large amounts of the soluble compounds produces changes in body weight, behavior, blood cells, choline esterase activity and sperm in experimental animals.

Acute Effects:

Inhalation: Toxic by inhalation. May cause irritation to the mucous membranes, coughing, dyspnea, soreness in the chest, weight loss, hemoptysis, bronchitis, asthma, pulmonary fibrosis and radiological changes in the lungs.

Ingestion: May cause irritation to the gastrointestinal tract and diarrhea.

Skin: May cause irritation.

Eye: May cause irritation.

Chronic Effects:

Inhalation: May cause damage to the lungs.

Ingestion: No chronic health effects recorded.

Skin: May cause dermatitis, sensitization and eczema.

Eye: May cause conjunctivitis.

Medical Conditions Generally Aggravated by Exposure: Pre-existing respiratory and skin disorders.

Target Organs: May affect the respiratory system.

Carcinogenicity: NTP: No IARC: No OSHA: No

EMERGENCY AND FIRST AID PROCEDURES:

INHALATION: Remove victim to fresh air. Keep warm and quiet, give oxygen if breathing is difficult and seek medical attention.

INGESTION: If conscious, give 1-2 glasses of milk or water and induce vomiting (Never induce vomiting or give anything by mouth to an unconscious person). Seek medical attention.

SKIN: Remove contaminated clothing from affected area, brush material off skin. Wash affected area with mild soap and water. Seek medical attention if symptoms persist.

EYE: Flush eyes with lukewarm water, lifting upper and lower eyelids, for at least 15 minutes. Seek medical attention if symptoms persist.

VI - REACTIVITY DATA

Stability: Stable

Conditions to Avoid: None

Incompatibility (Material to Avoid): Chlorine, fluorine, nitrogen dioxide, nitrous oxide, iodine pentafluoride and lead oxide.

Hazardous Decomposition Products: None recorded.

Hazardous Polymerization: Will not occur.

VII - SPILL OR LEAK PROCEDURES

Steps to Be Taken in Case Material Is Released or Spilled: Wear appropriate respiratory and protective equipment specified in Section VIII. Isolate spill area and provide ventilation. Vacuum up spill using a high efficiency particulate absolute (HEPA) air filter and place in a closed container for proper disposal. Take care not to raise dust.

Waste Disposal Method: Dispose of in accordance with all local, state, and federal regulations.

VIII - SPECIAL PROTECTION INFORMATION

Respiratory Protection: NIOSH approved dust, mist, and vapor cartridge respirator.

Ventilation: Use local exhaust ventilation which is adequate to limit personal exposure to airborne dust levels which do not exceed the appropriate PEL or TLV. If such equipment is not available, use respiratory protection as specified above.

Protective Gloves: Rubber gloves.

Eye Protection: Safety glasses.

Other Protective Clothing or Equipment: Protective gear suitable to prevent contamination.

IX - SPECIAL PRECAUTIONS

Precautions to Be Taken in Handling and Storage: Store in a tightly sealed container in a cool, dry, well-ventilated area. Wash thoroughly after handling.

Other Precautions: Implement engineering and work practice controls to reduce and maintain concentration of exposure at low levels. Use good housekeeping and sanitation practices. Do not use tobacco or food in work area. Wash thoroughly before eating or smoking. Do not blow dust off clothing or skin with compressed air.

The above information is believed to be correct, but does not purport to be all inclusive and shall be used only as a guide. Green Manufacturing, Inc. shall not be held liable for any damage resulting from handling or from contact with the above product.

The Quadwheel® is proudly manufactured in the USA by Green Manufacturing, Inc.

Green Manufacturing, Inc.
9650 Packard Rd
Morenci, MI 49256
Phone 800.473.3683 • Fax 517.458.1550

